

A.LEDA B-EYE K10 EASY

BASIC ENGINE

STANDARD

CHAN- NEL	CHANNEL MODE
1	Red
2	Red fine
3	Green
4	Green fine
5	Blue
6	Blue fine
7	White
8	White fine
9	Linear CTO
10	Macro colour
11	Strobe
12	Dimmer
13	Dimmer Fine
14	Pan
15	Pan Fine
16	Tilt
17	Tilt Fine
18	Function
19	Reset
20	Zoom

SHAPES

CHAN- NEL	CHANNEL MODE
1	Red
2	Red fine
3	Green
4	Green fine
5	Blue
6	Blue fine
7	White
8	White fine
9	Linear CTO
10	Macro colour
11	Strobe
12	Dimmer
13	Dimmer Fine
14	Pan
15	Pan Fine
16	Tilt
17	Tilt Fine
18	Function
19	Reset
20	Zoom
21	Shape Selection
22	Shape Speed
23	Shape Fade
24	Shape R
25	Shape G
26	Shape B
27	Shape W
28	Shape Dimmer
29	Background Dimmer
30	Shape Transition
31	Shape Offset
32	Foreground Strobe
33	Background Strobe
34	Background Select

PIXEL ENGINE

Pixel Engine need to be enabled through the FUNCTION channel (bit 103-105).

RGB

CHAN- NEL	CHANNEL MODE
1	Red LED 1
2	Green LED 1
3	Blue LED 1
...	Red LED ...
...	Green LED ...
...	Blue LED ...
55	Red LED 19
56	Green LED 19
57	Blue LED 19

RGBW

CHAN- NEL	CHANNEL MODE
1	Red LED 1
2	Green LED 1
3	Blue LED 1
4	White LED 1
...	Red LED ...
...	Green LED ...
...	Blue LED ...
...	White LED ...
73	Red LED 19
74	Green LED 19
75	Blue LED 19
76	White LED 19

A.LEDA B-EYE K10

BASIC ENGINE

STANDARD

CHAN- NEL	CHANNEL MODE
1	Red
2	Red fine
3	Green
4	Green fine
5	Blue
6	Blue fine
7	White
8	White fine
9	Linear CTO
10	Macro colour
11	Strobe
12	Dimmer
13	Dimmer Fine
14	Pan
15	Pan Fine
16	Tilt
17	Tilt Fine
18	Function
19	Reset
20	Zoom
21	Zoom Rotation

SHAPES

CHAN- NEL	CHANNEL MODE
1	Red
2	Red fine
3	Green
4	Green fine
5	Blue
6	Blue fine
7	White
8	White fine
9	Linear CTO
10	Macro colour
11	Strobe
12	Dimmer
13	Dimmer Fine
14	Pan
15	Pan Fine
16	Tilt
17	Tilt Fine
18	Function
19	Reset
20	Zoom
21	Zoom Rotation
22	Shape Selection
23	Shape Speed
24	Shape Fade
25	Shape R
26	Shape G
27	Shape B
28	Shape W
29	Shape Dimmer
30	Background Dimmer
31	Shape Transition
32	Shape Offset
33	Foreground Strobe
34	Background Strobe
35	Background Select

PIXEL ENGINE

Pixel Engine need to be enabled through the FUNCTION channel (bit 103-105).

RGB

CHAN- NEL	CHANNEL MODE
1	Red LED 1
2	Green LED 1
3	Blue LED 1
...	Red LED ...
...	Green LED ...
...	Blue LED ...
55	Red LED 19
56	Green LED 19
57	Blue LED 19

RGBW

CHAN- NEL	CHANNEL MODE
1	Red LED 1
2	Green LED 1
3	Blue LED 1
4	White LED 1
...	Red LED ...
...	Green LED ...
...	Blue LED ...
...	White LED ...
73	Red LED 19
74	Green LED 19
75	Blue LED 19
76	White LED 19

A.LEDA B-EYE K20

BASIC ENGINE

STANDARD

CHAN- NEL	CHANNEL MODE
1	Red
2	Red fine
3	Green
4	Green fine
5	Blue
6	Blue fine
7	White
8	White fine
9	Linear CTO
10	Macro colour
11	Strobe
12	Dimmer
13	Dimmer Fine
14	Pan
15	Pan Fine
16	Tilt
17	Tilt Fine
18	Function
19	Reset
20	Zoom
21	Zoom Rotation

SHAPES

CHAN- NEL	CHANNEL MODE
1	Red
2	Red fine
3	Green
4	Green fine
5	Blue
6	Blue fine
7	White
8	White fine
9	Linear CTO
10	Macro colour
11	Strobe
12	Dimmer
13	Dimmer Fine
14	Pan
15	Pan Fine
16	Tilt
17	Tilt Fine
18	Function
19	Reset
20	Zoom
21	Zoom Rotation
22	Shape Selection
23	Shape Speed
24	Shape Fade
25	Shape R
26	Shape G
27	Shape B
28	Shape W
29	Shape Dimmer
30	Background Dimmer
31	Shape Transition
32	Shape Offset
33	Foreground Strobe
34	Background Strobe
35	Background Select

PIXEL ENGINE

Pixel Engine need to be enabled through the FUNCTION channel (bit 103-105).

RGB

CHAN- NEL	CHANNEL MODE
1	Red LED 1
2	Green LED 1
3	Blue LED 1
...	Red LED ...
...	Green LED ...
...	Blue LED ...
109	Red LED 37
110	Green LED 37
111	Blue LED 37

RGBW

CHAN- NEL	CHANNEL MODE
1	Red LED 1
2	Green LED 1
3	Blue LED 1
4	White LED 1
...	Red LED ...
...	Green LED ...
...	Blue LED ...
...	White LED ...
145	Red LED 37
146	Green LED 37
147	Blue LED 37
148	White LED 37

NOTE: On conclusion of resetting in case of absence of DMX signal, Pan & Tilt move to the "Home" position (Pan 128 bit - Tilt 128 bit) all the others channels stay at 0 bit.

- RED
- GREEN
- BLUE
- WHITE



BIT	EFFECT
255	LED ON
0	LED OFF

- RED FINE
- GREEN FINE
- BLUE FINE
- WHITE FINE



BIT	EFFECT
255	UP
0	LOW

- LINEAR CTO

BIT	EFFECT
255	2500 K
...	...
224	3200 K
...	...
188	4000 K
...	...
144	5000 K
...	...
117	5600 K
...	...
99	6000 K
...	...
54	7000 K
...	...
10	8000 K
0-9	UNUSED RANGE

Note: If CTO channel is active, the WHITE channel is disabled.

- MACRO COLOUR

BIT	LEE REFERENCE	COLOUR	BIT VALUE			
			R	G	B	W
209-255	-	White	255	235	66	255
208	-	Dirty White	255	255	122	255
207	197	Alice Blue	128	255	143	0
191-206	181	Congo Blue	77	0	255	0
184-190	174	Dark Steel Blue	181	255	95	0
180-183	170	Deep lavender	255	168	64	0
179	169	Lilac Tint	255	199	49	0
175-178	165	Daylight Blue	82	214	90	0
174	164	Flame Red	255	46	2	0
172-173	162	Bastard Amber	255	181	28	0
168-171	158	Deep Orange	222	84	0	0
162-167	152	Pale Gold	253	171	26	0
157-161	147	Apricot	255	143	13	0
151-156	141	Bright Blue	0	255	87	0
149-150	139	Primary Green	77	255	0	0
147-148	137	Special lavender	219	197	79	0
146	136	Pale Lavender	255	197	61	0
145	135	Deep Golden Amber	255	58	0	0
142-144	132	Medium Blue	0	255	143	0
138-141	128	Bright Pink	255	53	36	0
136-137	126	Mauve	227	41	56	0
134-135	124	Dark Green	84	255	13	0
131-133	121	Leaf Green	206	255	0	0
129-130	119	Dark Blue	0	186	255	0
128	118	Light Blue	74	255	82	0
127	117	Steel Blue	206	255	56	0
126	116	Med Blu Green	206	255	56	0
125	115	Peacock Blue	51	255	51	0
123-124	113	Magenta	255	20	15	0
121-122	111	Dark Pink	255	109	33	0
120	110	Middle Rose	217	130	28	0
119	109	Light Salmon	255	138	31	0
118	108	English Rose	255	148	23	0
117	107	Light Rose	255	141	31	0
115-116	105	Orange	255	122	0	0
114	104	Deep Amber	255	166	0	0
113	103	Straw	230	160	0	69
112	102	Light Amber	237	163	0	0
110-111	100	Spring Yellow	245	202	0	0
100-109	90	Dark yellow green	41	219	0	0
89-99	79	Just Blue	0	194	130	0
78-88	68	Sky Blue	0	255	135	0
68-77	58	Lavender	243	117	133	199
62-67	52	Light Lavender	243	117	39	197
49-61	39	Pink Carnation	255	107	0	130
46-48	36	Medium Pink	255	87	0	107
45	35	Light Pink	255	112	0	141
35-44	25	Sunrise Red	255	83	2	0
32-34	22	Dark Amber	255	65	0	0
31	21	Gold Amber	255	100	0	0
30	20	Medium Amber	255	135	0	0
29	19	Fire	255	56	0	0
27-28	17	Surprise Peach	198	114	9	0
23-26	13	Straw Tint	152	115	9	0
20-22	10	Medium Yellow	156	126	0	0
19	-	Black	0	0	0	0
18	-	White 5000 K	255	137	0	193
17	-	White 3700 K	255	201	25	255
16	-	White 7000 K	216	237	61	255
15	-	Magenta	255	0	255	0
14	-	Yellow	255	255	0	0
13	-	Cyan	0	255	255	0
12	-	Blue	0	0	255	0
11	-	Green	0	255	0	0
10	-	Red	255	0	0	0
0-9	-	Macro color OFF	-	-	-	-

• STOP STROBE - FOREGROUND STROBE - BACKGROUND STROBE



BIT	EFFECT
252 - 255	OPEN
239 - 251	RANDOM FAST STROBE
226 - 238	RANDOM MEDIUM STROBE
213 - 225	RANDOM SLOW STROBE
208 - 212	OPEN
207	FAST PULSATION (25 flash/sec)
108	SLOW PULSATION (0,5 flash/sec)
104 - 107	OPEN
103	FAST STROBE (25 flash/sec)
4	SLOW STROBE (1 flash/sec)
0 - 3	CLOSED

• TILT

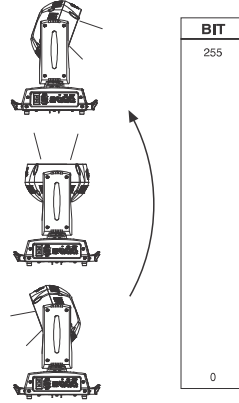

• TILT FINE

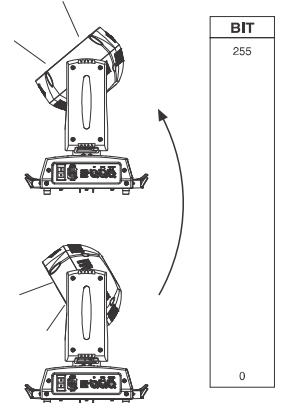

Operation with option InvertTilt \diamond Off

• DIMMER

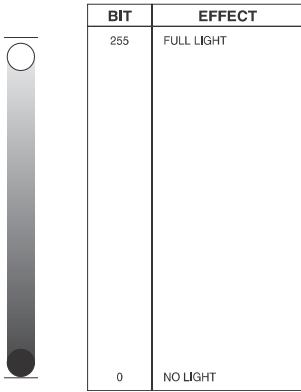

• DIMMER FINE

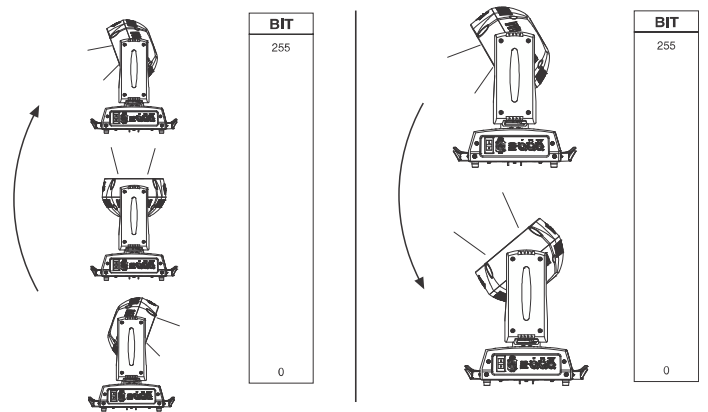
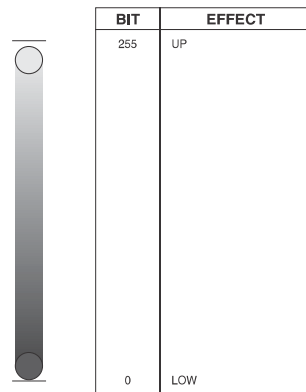

Operation with option InvertTilt \diamond On

• PAN

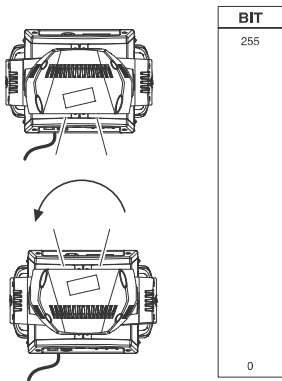

• PAN FINE

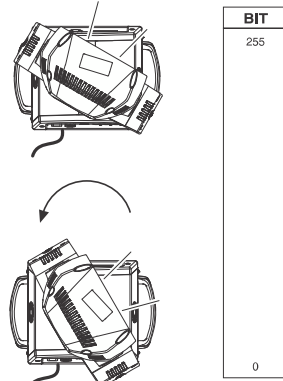

Operation with option InvertPan \diamond Off

• FUNCTION

BIT	EFFECT
106 - 255	Reserved
103 - 105	Pixel map enabled
98 - 102	Halogen Lamp Simulation - Linear CTO @ 0 bit - 2500 W
93 - 97	Halogen Lamp Simulation - Linear CTO @ 0 bit - 2000 W
88 - 92	Halogen Lamp Simulation - Linear CTO @ 0 bit - 1200 W
83 - 87	Halogen Lamp Simulation - Linear CTO @ 0 bit - 1000 W
78 - 82	Halogen Lamp Simulation - Linear CTO @ 0 bit - 750 W
73 - 77	Halogen Lamp Simulation OFF (Default)
68 - 72	RGBW Gamma curve 3 - gamma = 2.0
63 - 67	RGBW Gamma curve 2 - gamma = 1.5 (Default)
58 - 62	RGBW Gamma curve 1 - gamma = 1.0
53 - 57	Dimmer Curve 4
48 - 52	Dimmer Curve 3 (Default)
43 - 47	Dimmer Curve 2
38 - 42	Dimmer Curve 1
25 - 37	Pan Tilt Normal
12 - 24	Pan Tilt Fast (Default)
0 - 11	Unused Range

The functions are activated / selected passing through the " unused levels range " and staying in the necessary range for 5 seconds (except for the "Pixel map enabled" which is immediate). The last selected function remains active.

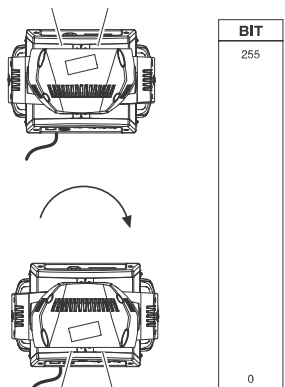

Operation with option InvertPan \diamond On

DIMMER CURVE 1 - GAMMA 1 LINEAR

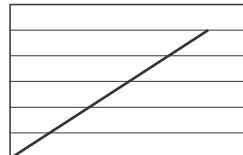

DIMMER CURVE 3 - GAMMA 2,0

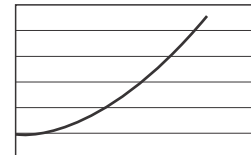

DIMMER CURVE 2 - GAMMA 1,5

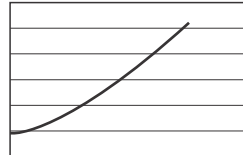

DIMMER CURVE 4 - S



• RESET

BIT	EFFECT
255	COMPLETE RESET
Complete reset is activated passing through the unused range and staying 5 seconds in complete reset levels	
128 127	COMPLETE RESET PAN / TILT RESET
Pan / Tilt reset is activated passing through the unused range and staying 5 seconds in Pan / Tilt reset levels	
77 76	PAN / TILT RESET ZOOM RESET
Effects reset is activated passing through the unused range and staying 5 seconds in Effects reset levels.	
26 25	ZOOM RESET
0	UNUSED RANGE

• ZOOM



BIT	EFFECT
255	WIDE BEAM
.....	
0	NARROW BEAM

• ZOOM ROTATION



BIT	EFFECT
255	FAST ROTATION
.....	
193	SLOW ROTATION
191 - 192	STOP
190	SLOW ROTATION
.....	
128	FAST ROTATION
127	
.....	
LINEAR ROTATION	
.....	
0	

• ZOOM ROTATION (available on zoom channel from 0 bit to 45 bit)

BIT	MACRO EFFECT
193-255	CCW Rotation, speed from 3 RPH to 10 RPM
191-192	Stop rotation
128-190	CW Rotation, speed from 10 RPM to 3 RPH
127	Indexed zone. Lens angle = 60,00
126	Indexed zone. Lens angle = 59,52
....	
3	Indexed zone. Lens angle = 1,42
2	Indexed zone. Lens angle = 0,94
1	Indexed zone. Lens angle = 0,47
0	Indexed zone. Lens angle = 0

• ZOOM ROTATION (available on zoom channel at 255 bit only)

BIT	MACRO EFFECT
128-255	Lens offset angle: 0.00 degree
127	Lens offset angle: +4.00 degree
126	Lens offset angle: +3.94 degree
125	Lens offset angle: +3.87 degree
....	
1	Lens offset angle: +0,06 degree
0	Lens offset angle: 0.00 degree

- RED LED 1 to...
- GREEN LED 1 to...
- BLUE LED 1 to...
- WHITE LED 1 to...



BIT	EFFECT
255	LED ON
.....	
0	LED OFF

SHAPE SPEED - SHAPE OFFSET - SHAPE FADE - BACKGROUND SELECT

Shape Selection	Shape Slot	Macro Name	On K10	On K20	Description	Random colors *1	SHAPE SPEED	SHAPE OFFSET	SHAPE FADE	BACKGROUND SELECT (*3)(*4)
0-7		Macro OFF	Yes	Yes		N.a.	N.a.	N.a.	N.a.	N.a.
8	1	Pixel 1	Yes	Yes	Static effects. The ring or rings used by the macro are turned-on with the foreground colour.	N.a.	N.a.	N.a.	N.a.	For K10: 0-7 = wash 8-15 = Bkgnd rings selection 16-255 = wash For K20: 0-7 = wash 8-23 = Bkgnd rings selection 24-255 = wash
9	2	Ring 1	Yes	Yes						
10	3	Ring 2	Yes	Yes						
11	4	Ring 3	No	Yes						
12	5	Pixel 1+Ring 1	Yes	Yes						
13	6	Pixel 1+Ring 2	Yes	Yes						
14	7	Pixel 1+Ring 3	No	Yes						
15	8	Single ring (Ramp +/-)	Yes	Yes		Yes	0-63 = Radius size, static. 64-158 = max to min speed, Closing effect 159-160 = STOP 161-255 = min to max speed, Opening effect	0-9 → continuous 10-255 → random distribution of flash	0-15 = Snap effect 16-255 = Fade effect and gamma selection	For K10: 0-7 = wash 8-15 = Bkgnd rings selection 16-255 = wash For K20: 0-7 = wash 8-23 = Bkgnd rings selection 24-255 = wash
16	9	Filled rings (ramp +/-)	Yes	Yes	Yes					
17	10	Open/Close 1	Yes	Yes	Yes					
18	11	Open/Close 2	Yes	Yes	Yes					
19	12	Random pixels 1	Yes	Yes		Yes	0-63 = Radius size, static. 64-158 = max to min speed, Closing effect 159-160 = STOP 161-255 = min to max speed, Opening effect	0-255 → select random distribution from 2 up to 20 fixtures	0-15 = Snap effect 16-255 = Fade effect and gamma selection	For K10: 0-7 = wash 8-15 = Bkgnd rings selection 16-254 = wash For K20: 0-7 = wash 8-23 = Bkgnd rings selection 24-254 = wash All Fixtures: 255 = Mirror Effect
20	13	Random pixels 2	Yes	Yes	Yes	0-63 = STOP 64-158 = max to min speed, Instant-on + fadeout. 159-160 = STOP. 161-255 = min to max speed, FadeIn + FadeOut.	0-255 → select pixel density			
21	14	Rainbow 1 (Variable speed)	Yes	Yes		N.a.	0-63 = Angle 0-360°, static. 64-158 = max to min speed, c.cw rotation 159-160 = STOP 161-255 = min to max speed, cw rotation	0-255 → angle offset from 0 to 360°	0-15 = Snap effect 16-255 = Fade effect and gamma selection	For K10: 0-7 = wash 8-15 = Bkgnd rings selection 16-255 = wash For K20: 0-7 = wash 8-23 = Bkgnd rings selection 24-255 = wash
22	15	Rainbow 2 (Fixed speed with variable color offset)	Yes	Yes		N.a.	0-63 = STOP 64-158 = c.cw rotation 159-160 = STOP 161-255 = cw rotation The value 64-158 or 161-255 change the rainbow angle offset (the orange starting angle).	N.a.	0-15 = Snap effect 16-255 = Fade effect and gamma selection	For K10: 0-7 = wash 8-15 = Bkgnd rings selection 16-255 = wash For K20: 0-7 = wash 8-23 = Bkgnd rings selection 24-255 = wash
23	16	Fan	Yes	Yes		N.a.	0-63 = angle offset, 0-360° 64-158 = max to min speed, c.cw rotation 159-160 = STOP 161-255 = min to max speed, cw rotation	0-255 → angle offset from 0 to 360°	0-15 = Snap effect 16-255 = Fade effect and gamma selection	For K10: 0-7 = wash 8-15 = Bkgnd rings selection 16-255 = wash For K20: 0-7 = wash 8-23 = Bkgnd rings selection 24-255 = wash For all fixtures: - Macro 25, 26 255 = Mirror Effect with bkgnd color - Macro 27, 28, 29 255 = Show Alternative Color
24	17	Bar 1	Yes	Yes						
25	18	Half moon	Yes	Yes						
26	19	Triangle	Yes	Yes						
27	20	Segment 1	Yes	Yes						
28	21	Arc 1	Yes	Yes						
29	22	Arc 2	Yes	Yes						

*1: Random colors activation with foreground R,G,B,W = 0

*2: Aleda K10: macro 65 = Random on ring 1+3; macro 66 = Random on ring 2+3

*3: See Aleda K10 Background Rings Selection table

*4: See Aleda K20 Background Rings Selection table

Shape Selection	Shape Slot	Macro Name	On K10	On K20	Description	Random colors *1	SHAPE SPEED	SHAPE OFFSET	SHAPE FADE	BACKGROUND SELECT (*3)(*4)	
30	23	Bar 2 (Variable size)	Yes	Yes		N.a.	0-63 = STOP, indexed speed 64-158 = max to min speed, c.cw rotation. 159-160 = STOP. 161-255 = min to max speed cc rotation.	0-255 → select shape width	Linear fade	For K10: 0-7 = wash 8-15 = Bkgnd rings selection 16-254 = wash 255 = Mirror effect with bkgnd color For K20: 0-7 = wash 8-23 = Bkgnd rings selection 24-254 = wash 255 = Mirror effect with bkgnd color Note: Mirror effect unavailable for macro 31. Macro 67, 68, 69: the mirror effect is available only for options 1, 3, 9	
31	24	Random explosion	Yes	Yes		Yes		0-255 → select random distribution	Linear fade and wake length		
32	25	Segment 2	Yes	Yes				0-255 → select shape width			
33	26	x Bump	No	Yes				0-255 → select macro offset	Linear fade		
34	27	Image	No	Yes							
35	28	Bumping section	Yes	Yes							
36	29	Ramp by 6	Yes	Yes				0-255 → select shape width	Linear fade and wake length		
37	30	Ramp by 4	Yes	Yes							
38	31	Left/Right scrolling bar	Yes	Yes							
39	32	Up/Down scrolling bar	Yes	Yes							
40	33	Bar 3	Yes	Yes				0-255 → select macro offset	Linear fade		
41	34	Vertical arc 1	No	Yes							
42	35	Vertical arc 2	Yes	Yes							
43	36	Horizontal arc 1	No	Yes							
44	37	Horizontal arc 2	Yes	Yes							
45	38	Mirrored pixel	Yes	Yes				0-255 → select shape width	Linear fade and wake length		
46	39	Pixel animation 1	Yes	Yes							
47	40	Pixel animation 2	Yes	Yes		N.a.					
48	41	Pixel animation 3	Yes	Yes							
49	42	Pixel animation 4	Yes	Yes							
50	43	Pixel animation 5	Yes	Yes							
51	44	Semi arc (Ramp /+)	Yes	Yes							
52	45	Bumping arc section	Yes	Yes				0-255 → select macro offset	Linear fade		
53	46	Pixel animation 6	Yes	Yes							
54	47	Vertical ramp by 2	Yes	Yes				0-255 → select shape width	Linear fade and wake length		
55	48	Following pixel by 2	Yes	Yes							
56	49	Syncopation	Yes	Yes				0-255 → select macro offset	Linear fade		
57	50	Bumping 1	Yes	Yes							
58	51	Bumping 2	Yes	Yes							
59	52	Bumping 3	Yes	Yes							
60	53	Vertical pixel scrolling	Yes	Yes				0-255 → select macro width	Linear fade and wake length		
61	54	Random vertical section	Yes	Yes				0-255 → select random distribution	Linear fade		
62	55	Random central section	Yes	Yes		Yes					
63	56	Random ring 2	Yes	Yes		Yes					
64	57	Random ring 3	No	Yes		Yes					
65	58	Random ring 1+3	Yes (*2)	Yes		Yes					
66	59	Random ring 2+3	Yes (*2)	Yes		Yes					
67	60	Single pixel ring 1	Yes	Yes				0-255 → select the number of rotating	Linear fade and wake length		
68	61	Single pixel ring 2	Yes	Yes							
69	62	Single pixel ring 3	No	Yes		N.a.					
70	63	Spiral	Yes	Yes				0-255 → select macro width	Linear fade and wake length		
71-255	64					N.a.		N.a.	N.a.		N.a.

• SHAPE FADE

BIT	EFFECT
246-255	Smooth, fading curve with automatic gamma *
245	Smooth, fading curve gamma 2
243	Smooth, fading curve gamma 1,986
244	Smooth, fading curve gamma 1,993
...	...
18	Smooth, fading curve gamma 0,513
17	Smooth, fading curve gamma 0,506
16	Smooth, fading curve gamma 0,5
0-15	Snap

• SHAPE TRANSITION

BIT	EFFECT
255	4 sec
...	...
216	3 sec
...	...
171	2 sec
...	...
113	1 sec
...	...
73	0,5 sec
...	...
5	100 ms
0-4	No fade

• SHAPE RGBW
SHAPE DIMMER
BACKGROUND DIMMER



BIT	EFFECT
255	LED ON
...	...
0	LED OFF

• BACKGROUND SELECT
Aleda K10 - Background select

BIT	EFFECT
255	Mirror effect
16-254	No selection
...	...
15	Ring 2 + Ring 3
14	Pixel 1 + Ring 2 + Ring 3
13	Pixel 1 + Ring 2
12	Pixel 1 + Ring 3
11	Ring 3
10	Ring 2
9	Pixel 1
8	No selection

Aleda K20 - Background select

BIT	EFFECT
255	Mirror effect
24-254	No selection
...	...
23	Pixel 1 + Ring 2 + Ring 4
22	Pixel 1 + Ring 3 + Ring 4
21	Ring 2 + Ring 4
20	Pixel 1 + Ring 3
19	Ring 2 + Ring 3
18	Pixel 1 + Ring 4
17	Ring 3 + Ring 4
16	Ring 2 + Ring 3 + Ring 4
15	Pixel 1 + Ring 2 + Ring 3 + Ring 4
14	Pixel 1 + Ring 2 + Ring 3
13	Pixel 1 + Ring 2
12	Ring 4
11	Ring 3
10	Ring 2
9	Pixel 1
8	No selection

A.LEDA B-EYE K10 & K10 EASY

LED reference number for pixel mapping
TILT: channel 16 @ 200 bit

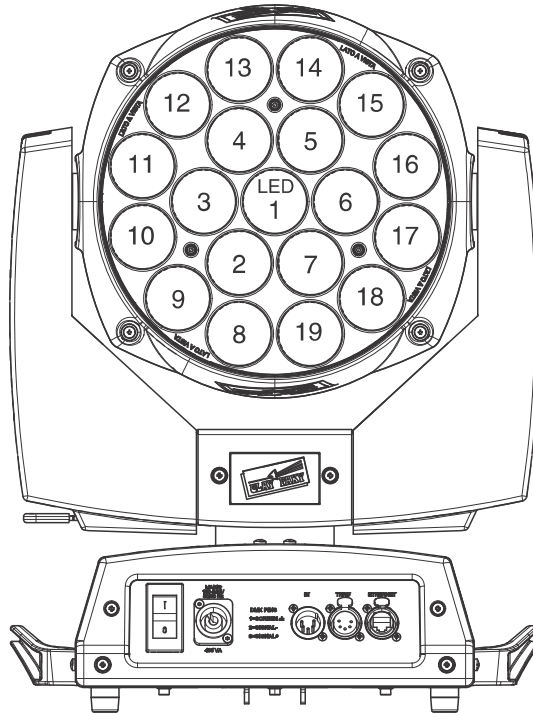

A.LEDA B-EYE K20

LED reference number for pixel mapping
TILT: channel 16 @ 200 bit

